



**Donaldson**  
FILTRATION SOLUTIONS

# COMPRESSED AIR AND PROCESS FILTRATION





## Solutions backed by experience, know-how and responsibility

Our passion is to add value to our customers by providing future-oriented compressed air and process filters and systems that are optimized from standpoints of energy consumption, efficiency and cost effectiveness. We are certain that our state of the art facilities, coupled with our extensive technical experience and engineering expertise, will guarantee excellence in the solutions we deliver.

As a technology-driven organization we've been strongly investing in research and development serving as incubator for the development of all products marked with the "Turbo D".

Our global network of scientists and engineers is continuously developing next-generation products and services. While continuously pursuing innovation and new technologies in design, manufacturing and delivery, we are also sharply focused on environmental issues, energy and resource management as well as corporate health and safety. We believe in sustainability that pays off!

Let us guide you through the specification and development of energy-efficient and cost-effective filtration solutions.

Feel free to contact us on [CAP-europe@donaldson.com](mailto:CAP-europe@donaldson.com)

# ABOUT DONALDSON

## Everything from one single source

### 100 years of filtration experience

Donaldson is a leading worldwide provider of filtration solutions and media manufacturer covering the entire process chain. From development through production to distribution and maintenance – you can get everything from one single source.

Since 1915, our innovative technologies improve people’s lives, enhance equipment performance and help to protect the environment. We are a technology-driven company that promises no less than the best solutions for high quality compressed air purification, sterile air, steam and liquid filtration.

### Our products are engineered to

- improve filtration efficiency
- extend filter lifetime
- guarantee a maximum of energy savings
- ensure a high product quality

### This is included in our first class service:

- Total customer care commitment
- Service for compressed air purification
- Leading filtration expertise
- Local presence

### Versatile filtration solutions for compressed air applications

The Ultra-Filter was developed on the basis of worldwide experience and innovative designs for highly efficient and economic filtration technology.

- A flow-optimised filter design guarantees minimum pressure loss
- The innovative filtration technology ensures high separation efficiency
- An intelligent overall concept for unrivalled efficiency
- New filtration technology UltraPleat® reduces the differential pressure and this with consistently high filtration performance
- Validated performance data acc. to ISO 12500-1 (oil aerosols), 12500-2 (oil vapours) and 12500-3 (particles)
- Reliable achievement of the compressed air quality to suit the application acc. to ISO 8573-1
- 1935/2004/EC approved for indirect food contact

### Worldwide service



Total filtration service for compressed air.

### Success factors of the UltraPleat® technology



New filter media and improved pleat (form and structure)

Improved filter media coating

Outer stainless steel liner

The proven UltraPleat® technology is available for filter elements S and M.

# PURIFICATION OF COMPRESSED AIR, GASES AND LIQUIDS

## Tailor-made solutions for your application

### Compressed air purification

Donaldson delivers a complete system of filtration and separation products for compressed air systems. Donaldson's technology in the field of compressed air, gas and liquid separation extends from the compressor room to all points of use in the factory. Components are designed and matched for optimal performance.

Donaldson's engineering service leads new products from concept to implementation. The product portfolio covers industrial filters, refrigeration and adsorption dryers as well as condensate treatment.

### Process filtration

Where quality requirements are exceptionally high, Donaldson has a selection of process filters which will enable you to reach maximum purity standards. For these purposes Donaldson supplies pre- and sub-micro filters for liquids, for compressed air, gases and sterile air systems.

### Filter housings



Filter housings for the aeration on storage tanks.

### Adsorption dryer and system solutions

Processing concepts consisting of filtration and drying are an integral part of various compressed air applications. Donaldson designs and manufactures complete solutions that are tailor-made to individual customer requirements. This guarantees high reliability and simultaneously efficient operation.

### Ultracac® Smart



Ultracac® Smart heatless regenerated adsorption dryer for pure air.

How can we meet your filtration needs? Please contact us on [CAP-europe@donaldson.com](mailto:CAP-europe@donaldson.com)



# PRODUCT HIGHLIGHTS

## Innovation in Compressed Air Purification & Liquid, Steam and Sterile Air

### Ultracac® Smart

NEW!



The very quiet adsorption dryer Ultracac® Smart offers a stable pressure dew point at minimal regeneration air requirements and innovative UltraPleat® filtration technology.

**More information on page 18.**

Quiet,  
modular,  
Industry 4.0  
ready

### Ultra-Filter DF

PROVEN  
TECHNOLOGY



New filtration technology UltraPleat® reduces the differential pressure and this with consistently high filtration performance.

**More information on page 14.**

UltraPleat®  
Technology

### LifeTec®

NEW!



The new liquid process filtration range: High flow rate for sterile grade-filtration and high particle retention capacities for prefiltration.

**More information on page 17.**

Excellent  
flow rate

### (P)-SRF C/V/X

NEW!



The new sterile air filters offer a high retention rate down to 3 nm (nanometers) and are reliable even under extreme conditions.

**More information on page 17.**

Suited for  
the use in  
applications with  
VPHP and ozone  
sterilization

# DONALDSON WORLDWIDE

Donaldson is where you are

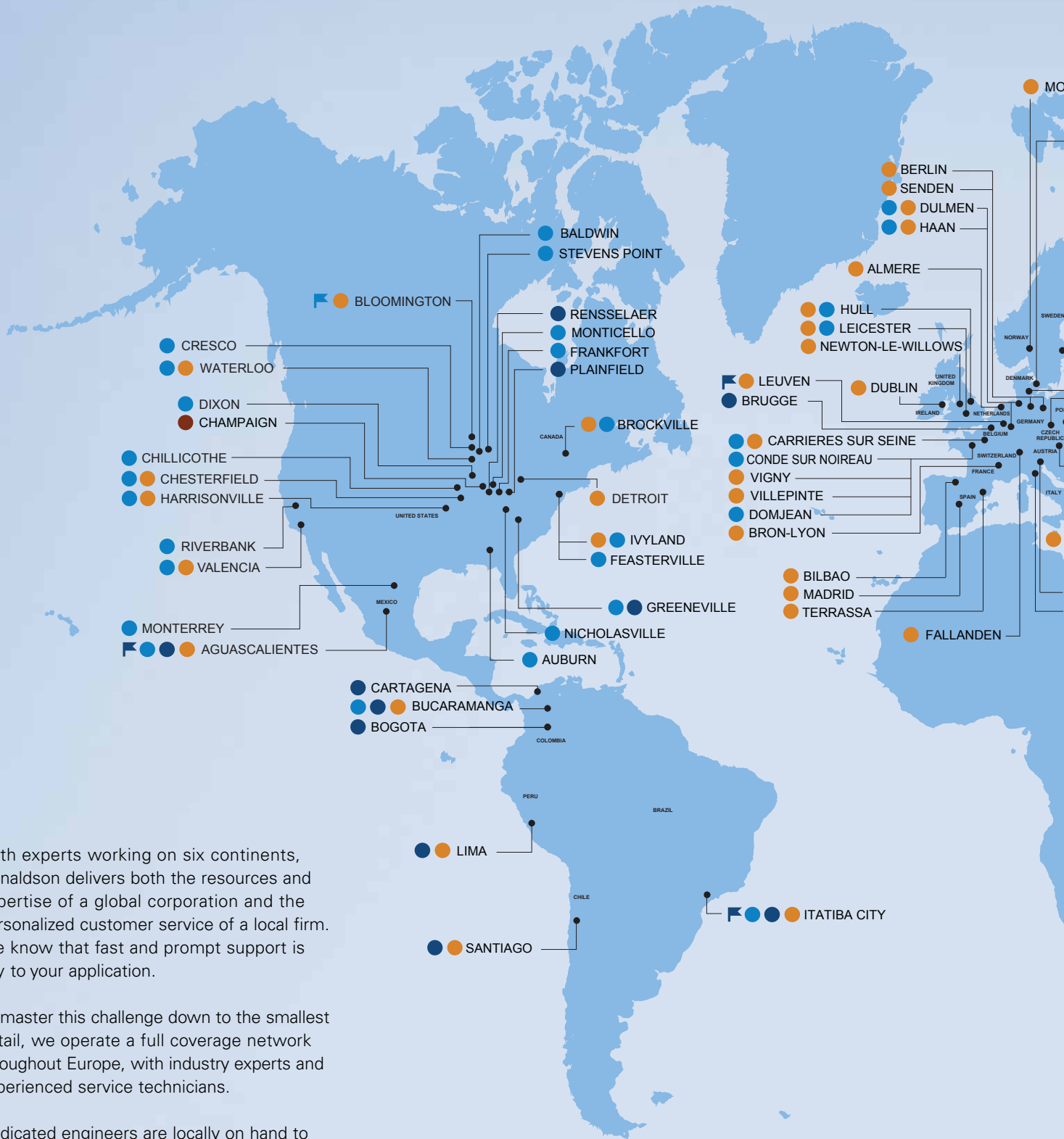







With experts working on six continents, Donaldson delivers both the resources and expertise of a global corporation and the personalized customer service of a local firm. We know that fast and prompt support is key to your application.

To master this challenge down to the smallest detail, we operate a full coverage network throughout Europe, with industry experts and experienced service technicians.

Dedicated engineers are locally on hand to assist or plan application specifications, implement system installation and look after ongoing maintenance.



**Legend:**

-  World Headquarters
-  Regional Headquarters
-  Manufacturing
-  Distribution Centers
-  Joint Ventures
-  Sales

# INDUSTRIES AND APPLICATIONS

**You are committed to manufacturing excellence – so are we**

We offer a wide variety of tailor-made services for these applications. For example a complete filtration portfolio of innovative solutions for air & gas, steam and liquids. All products are designed to reach maximum purity standards and fulfil highest quality requirements.

## **Reliable product quality**

All filter elements are produced, packaged and shipped under strict controls in an exact manner and meet the quality and performance data that are stored in the product specification.

### **Industrial machinery**



### **Electrical machinery**

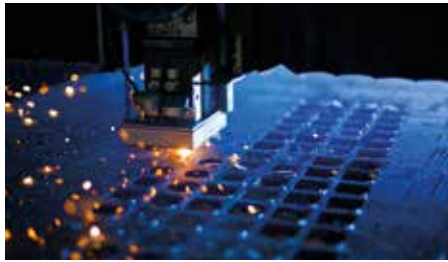

### **Automotive**



### **Oil and gas**



### **Industrial gases**



### **Paints and coatings**



### **Energy**



### **Environment**



Feel free to send your request to [CAP-europe@donaldson.com](mailto:CAP-europe@donaldson.com)





**Regardless of the filtration application you are responsible for:** Donaldson is your partner! In decades of close cooperation with our customers, we have gathered expert knowledge in nearly all fields of industrial production.

**Food processing**



**Food manufacturing**



**Dairies**



**Soft drinks and water**



**Winery**



**Breweries**



**Pharmaceutical**



**Chemical**



**Medical**



**Packaging and bottling**



**Beverages**



# COMPRESSED AIR PURIFICATION

## Tailor-made solutions for compressed air purification

- 1 Compressor
- 2 **UFK-W** Aftercooler (water cooled)
- 3 **DF-C** Cyclone Separator
- 4 Air Receiver Vessel
- 5 **DF-V** Coalescence Filter (included in Buran DC)
- 6 Refrigeration Dryer (Buran DC incl. pre- and afterfilter)
- 7 **DF-M** Coalescence Filter (included in Buran DC)
- 8 **OFF 2000** Adsorption Dryer with Oil Vapour Adsorber
- 9 **DF-S** Particulate Filter
- 10 **DF-T** Three-Stage Filter (Coalescence Filter, Oil Vapour Filter, Particulate Filter)
- 11 **ALD** Adsorption Dryer (incl. pre- and afterfilter)
- 12 **AKC** Oil Vapour Adsorber
- 13 **DF-A** Oil Vapour Filter
- 14 **ALG-S** Breathing Air Unit
- 15 **UFM-D** Condensate Drain
- 16 **UFS-SP** Oil/Water Separator

**Legend:** — Compressed Air      ..... Condensate

Compressed air quality class	Dirt (solid particles) Maximum particle number per m <sup>3</sup> particle size, d in µm			Water Pressure dewpoint °C	Oil Concentration mg/m <sup>3</sup>
	0.10 < d ≤ 0.5	0.5 < d ≤ 1.0	1.0 < d ≤ 5.0		
0	Specified acc. to application and better than Class 1				
1	20,000	400	10	≤ 70	≤ 0.01
2	400,000	6,000	100	≤ 40	≤ 0.1
3	n.s.	90,000	1,000	≤ 20	≤ 1
4	n.s.	n.s.	10,000	≤ +3	≤ 5
5	n.s.	n.s.	100,000	≤ +7	> 5

Compressed air quality acc. to ISO 8573-1

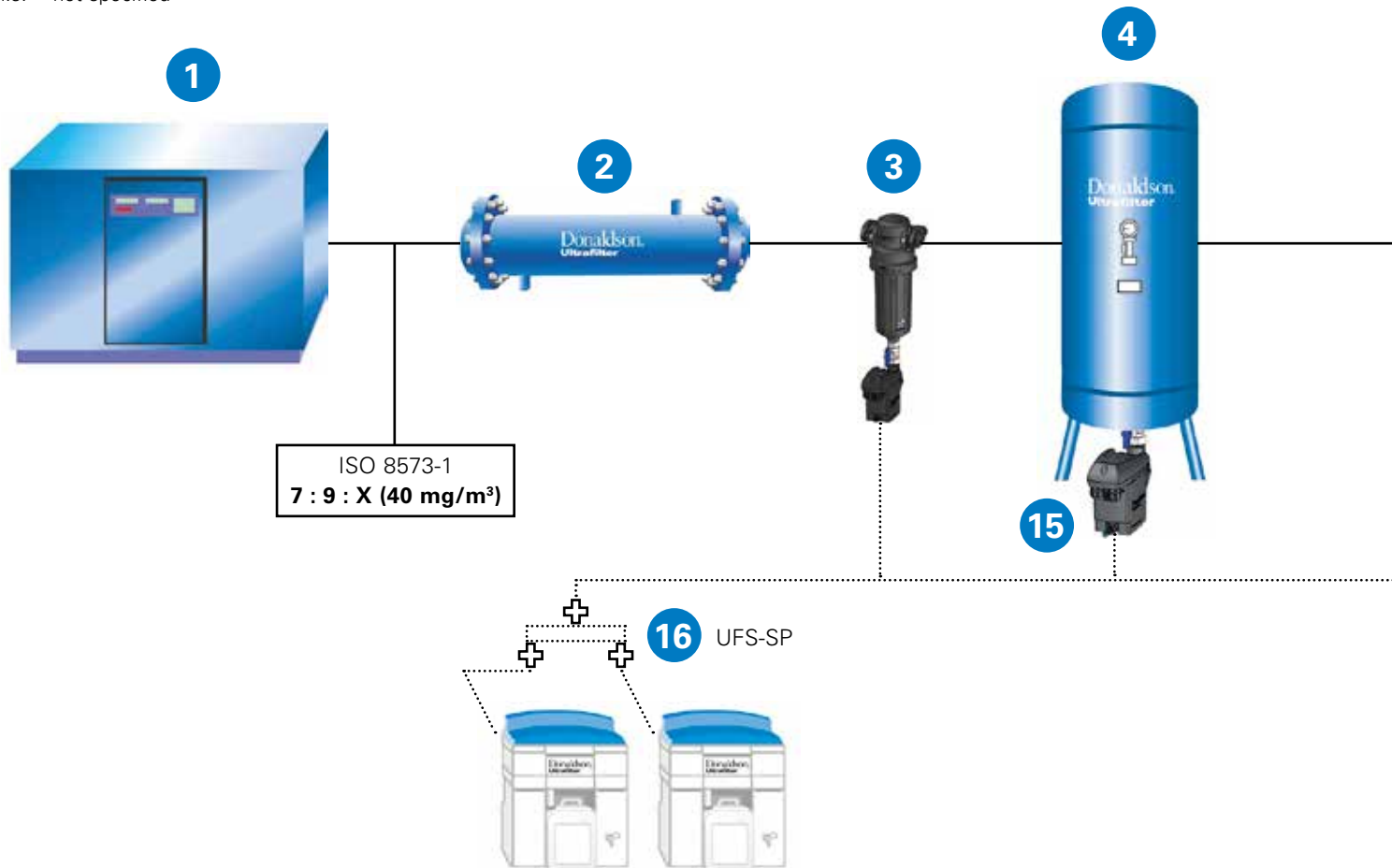

n.s. = not specified

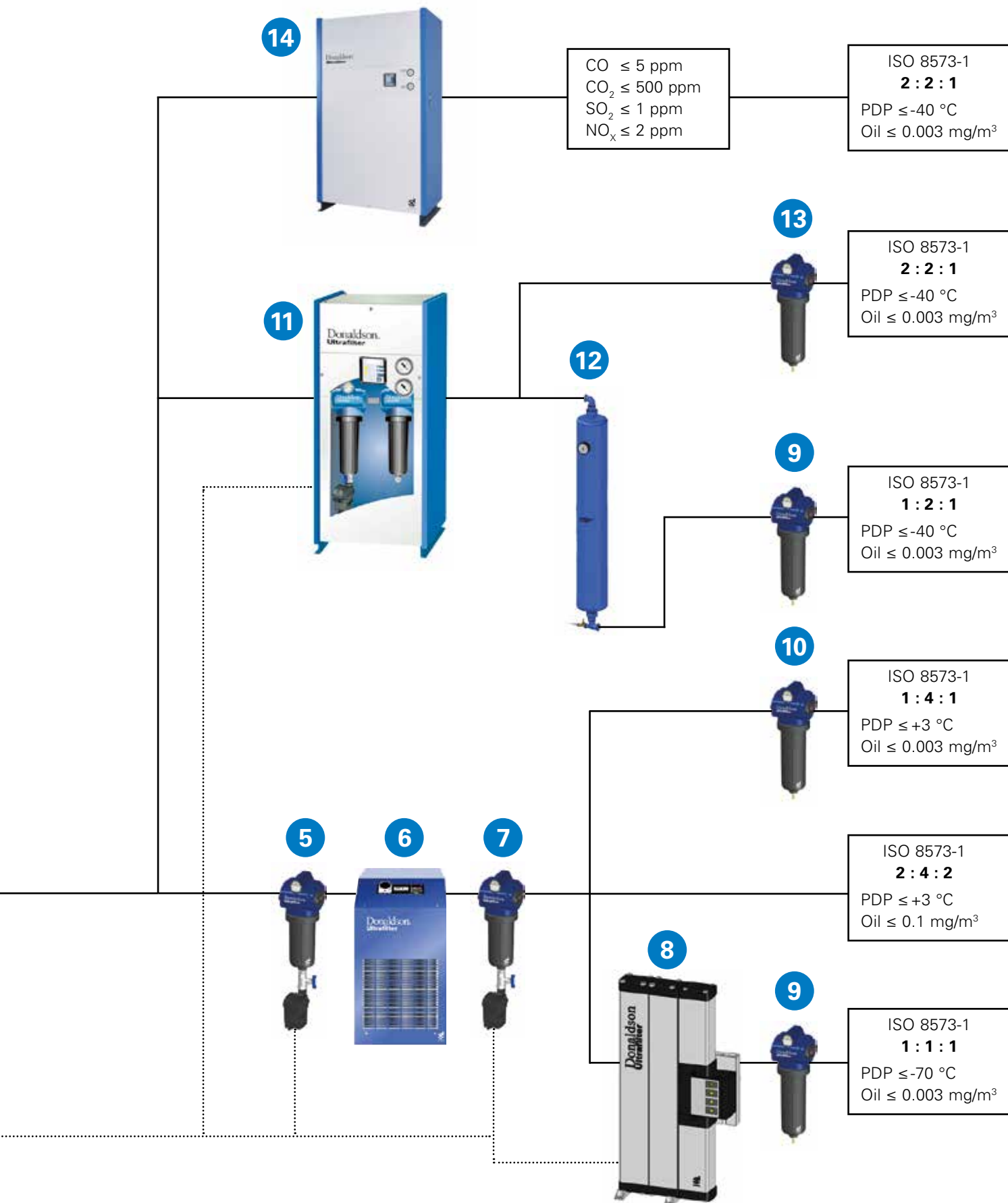





































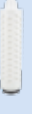

# PRODUCT FINDER

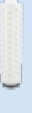
## Compressed air

Water-free	Particle-free	Oil-free	Drying	Odour-free
<p>UFK-W </p> <p>UFK-L </p> <p>DF-C </p> <p>AG-Z </p> <p>SG-Z </p>	<p>DF </p> <p>SG </p> <p>DFX </p> <p>HD </p> <p>VX </p> <p>UltraPleat® MX </p> <p>UltraPleat® SX </p> <p>P </p> <p>B </p>	<p>DF </p> <p>SG </p> <p>DFX </p> <p>HD </p> <p>VX </p> <p>UltraPleat® MX </p> <p>UltraPleat® SX </p> <p>AX </p> <p>DF-T </p> <p>A </p> <p>V </p> <p>UltraPleat® M </p> <p>UltraPleat® S </p>	<p>Buran </p> <p>Boreas </p> <p>Brisa </p> <p>Bora </p> <p>SPN </p> <p>FRL </p> <p>Ultrapac HED/ALD/MSD </p> <p>Ultrapac® Smart </p> <p>HLP </p> <p>HRC/HRE HRG/HRS HRG+ </p>	<p>ALG 20 </p> <p>ALG </p> <p>Ultrapure 2000 Medipac 2000 </p> <p>Oilfreepac 2000 </p> <p>OFF </p> <p>Nitropac </p> <p>Ultraspac Smart AKC </p> <p>AKC </p> <p>DFX </p> <p>AX </p> <p>DF-T </p> <p>A </p>

## Process filtration

Sterile	Condensate	Steam	Gases	Liquid
<p>P-BE </p>	<p>UFM-D </p>	<p>P-EG </p>	<p>(P)-SRF C </p>	<p>PF-EG </p>
<p>P-EG </p>	<p>UFM-P </p>	<p>P-EGS </p>	<p>(P)-SRFV </p>	<p>P-KG </p>
<p>PG-EG </p>	<p>UFS-SP N </p>	<p>PG-EG </p>	<p>(P)-SRF X </p>	<p>(P)-SM N </p>
<p>(P)-SRF C </p>	<p>UFA-AC </p>	<p>(P)-GS N </p>	<p>LifeTec® PT N </p>	<p>LifeTec® PT N </p>
<p>(P)-SRFV </p>		<p>(P)-GSL N </p>	<p>P-EG </p>	<p>LifeTec® PES WN </p>
<p>P-SLF </p>		<p>(P)-GS VE </p>	<p>PG-EG </p>	<p>LifeTec® PP 100 N </p>
			<p>UFTD </p>	<p>LifeTec® PP 100 CN </p>
			<p>P-BE </p>	<p>LifeTec® PP N </p>
			<p>(P)-GSL N </p>	<p>LifeTec® PP-TF N </p>
			<p>R-EG </p>	<p>LifeTec® PES BN </p>
				<p>PP-FC PP-FC 100 </p>
				<p>(P)-GSL N </p>

# COMPRESSED AIR FILTRATION AND PURIFICATION

## Compressed air filter Ultra-Filter DF

PROVEN  
TECHNOLOGY

UltraPleat®  
Technology



### Ultra-Filter DF

- Flow rate from 35 m³/h to 1,100 m³/h
- Flow-optimised filter housing and filter element design
- Validated performance acc. to ISO 12500-1 (oil aerosols), ISO 12500-2 (oil vapours) and ISO 12500-2 (particulates)
- Outer and inner surfaces protected against corrosion
- Compact, service-friendly design due to bayonet-fixing, low space requirement and simple handling during filter element exchange
- Economizer function with digital differential pressure gauge

### High pressure filter housing HD

- Working pressure 20 bar to 400 bar
- Suitable for compressed air and technical gases

### DFX filter housings

- Housings made of aluminum, designed for operating pressure up to 25 bar and operating temperatures from -20 °C up to +120 °C

### Silicone free filters

- Specifically designed for use in the automotive and paint industries

## Three stage filter DF-T

NEW!



### DF-T (three) stage filter

- This unique filter element combines three high efficiency purification stages in one single element
- Sub-micro coalescence filter
- Activated carbon adsorbent
- High efficiency particle filter
- Nominal flow rates up to 110 m³/h @ 7 bar
- Economizer offers control filter lifetime and differential pressure
- Compact space saving solution for point of use application
- Service advantages vs. multiple housing combination

Up to 60%  
installation space  
can be reduced in  
comparison to a  
three filter  
combination

## Cyclone Separator DF-C



### Cyclone Separator DF-C

- Cyclone Separator will remove bulk water, oil droplets as well as solid particulates from the compressed air stream
- Innovative spin insert ensures low differential pressure and simultaneously lowered requirements of energy, the cyclone separator offers substantial cost savings
- High retention rates over large flow range
- Bayonet fixing between housing head and bowl for ease of inspection and cleaning
- DF-C Superplus including UFM-D condensate drain

# BREATHING AIR SYSTEMS

## Ultrapure ALG 20

---



### Ultrapure ALG 20

- Flow rate of 60 m<sup>3</sup>/h
- Four persons can be provided with breathing air
- Portable version in stable housing with 2 or 3 filter stages, depending on the contamination of the compressed air
- Easy maintenance and filter change
- ATEX version available

## Ultrapure 2000

---



### Ultrapure 2000

- Purification package including adsorption dryer, CO-, CO<sub>2</sub>-, NOX- and SO<sub>2</sub> removal, pre-, afterfilter and automatic condensate drain
- Breathing air quality in excess of all relevant international standards
- Compact, modular and space-saving design solution
- Adsorbent in cartridges for easy and clean exchange

## Ultrapure ALG

---



### Ultrapure ALG

- Breathing air system with adsorption dryer
- CO, CO<sub>2</sub>, SO<sub>2</sub>, NOX precipitation to meet all relevant international breathing air specifications
- Cabinet design solution
- Pre- and afterfilters included; zero-loss condensate drain on prefilters
- Optimal adaption and generous dimensioning of all components for long lifetimes of processing stages and low differential pressure
- Controller including operating status LED, alarm and service messages

# COMPRESSED AIR FILTRATION

## Compressed air filter housings

---



### AG & SG filter housings

- Flow rate from 1,440 m<sup>3</sup>/h to 2,880 m<sup>3</sup>/h (AG) and from 1,080 m<sup>3</sup>/h to 38,400 m<sup>3</sup>/h
- Low pressure drop
- Include differential pressure gauge
- SG available with ATEX specification
- Maximum working pressure 16 bar

### AG-Z & SG-Z Cyclone Separators

- Flow optimised filter housing design
- Cyclone Separator will remove bulk water, oil droplets as well as solid particulates from the compressed air stream
- Retention rate > 99% for particle size of 10 µm and larger
- AG-Z Superplus including UFM-D condensate drain

## Compressed air filter elements

---

**PROVEN  
TECHNOLOGY**



### Filter elements

- Available as prefilter and activated carbon filter
- UltraPleat® filtration technology
- Low differential pressure
- High dirt holding capacity
- Longer service life
- Lowest filtration costs
- Validated performance acc. to ISO 12500-1 (oil aerosols), ISO 12500-2 (oil vapours) and ISO 12500-2 (particulates)

## Replacement filter

---



### Replacement filter elements

- Improved filtration efficiency
- Lower differential pressure
- Longer service life
- Lower filtration costs
- Higher efficiency
- More energy saving
- Lower initial and operational costs
- Hundreds of varieties to choose from stock



# FILTERS FOR STERILE AIR, LIQUIDS AND STEAM

## Sterile air filter

**NEW!**



### (P)-SRF C/V/X

- High retention rate down to 3 nm (nanometers)
- High temperature & mechanical resistance
- Reliable under extreme conditions
- Last for more than 160 sterilization cycles
- Suited for the use in applications with VPHP and ozone sterilization

Suitable for temperatures up to +200 °C

## Steam filter

**PROVEN TECHNOLOGY**



### (P)-GSL N

- High dirt holding capacity at a low differential pressure and a high flow rate
- Can be regenerated by back washing and ultrasonication
- Retention rate > 99.996 % at 0.01 µm
- Suitable for temperatures from -20 °C up to +200 °C
- Also available as 5 µm grade for culinary steam
- Suitable for food contact use acc. to CFR Title 21 & 1935/2004/EC

Retention rate down to 0.01 µm in saturated steam

## Liquid filter

**NEW!**



### LifeTec®

- Absolute ratings of 0,2 µm, 0,45 µm & 0,6 µm
- Outstanding flow rate
- Highly resistant materials
- Extremely low adsorption of proteins
- High thermal stability, permanently hydrophilic
- Approved for food contact use acc. to CFR Title 21 & 1935/2004/EC
- A selection of stainless steel housings for your application are available

Food approved

# ADSORPTION DRYERS

## Heatless regenerated adsorption dryers

---

NEW!



### Ultrapac® Smart

- Compact design with integrated pre- and afterfilter
- Exceptionally quiet
- Modular and space-saving design
- Flow rate 5 to 100 m<sup>3</sup>/h
- Stable dew point -40 to -70 °C

## Heatless regenerated adsorption dryers

---



### Ultrapac HED/ALD/MSD

- Complete and compact purification package with pre- and afterfilter
- Flow rate 5 m<sup>3</sup>/h to 1,000 m<sup>3</sup>/h
- PDP -40 °C/-70 °C

## Heat regenerated adsorption dryers

---



### HRE

- All climate zones
- Very flexible solutions
- Low investment costs
- Easy maintenance

### HRC

- Energy-saving (zero purge)
- Low operating costs
- Designed for fully automatic and continuous operation
- Cooling with ambient air
- Easy maintenance

### HRS

- High energy-saving (zero purge, low desorption temperature)
- Low operating costs
- Easy maintenance

### HRS-L

- Worldwide applicable
- Energy-saving (zero purge)
- Low operating costs
- Easy maintenance
- Pressure dew point up to -70 °C

Further adsorption dryers concepts HRI, HRC, ARBG Biogas are available on request.

# REFRIGERATION COMPRESSED AIR AND MEMBRANE DRYERS

## Refrigeration compressed air dryer

**NEW!**



### Buran

- Flow rate 20 m<sup>3</sup>/h to 1,175 m<sup>3</sup>/h
- Reliable pressure dew point +3 °C
- Corrosion resistant aluminium heat exchanger
- Plug & play solution; with integrated filters for 20 m<sup>3</sup>/h – 850 m<sup>3</sup>/h range
- Environmentally friendly refrigerant R407c/R134a with high overload capacity

## Refrigeration compressed air dryer

**NEW!**



### Boreas

- Volume flow 1,260-21,000 m<sup>3</sup>/h
- Variable speed control (energy savings under partial load conditions)
- Electronic-level-controlled condensate drain on the heat exchanger

### Bora

- Flow rate 25- 6,060 m<sup>3</sup>/h
- Working pressure up to 45 bar
- Ideal for PET applications
- Hot gas bypass control

## Membrane dryer



### VarioDry SPN

- Very low purge air
- Lightweight design
- Nine types with 3.0 m<sup>3</sup>/h up to 63 m<sup>3</sup>/h
- Dew point reduction down to -40 °C or variable reduction
- Diagonal cross wrapped fibres
- Maintenance free and easy to install
- No electrical supply required
- Almost noiseless operation
- SPN Superplus including prefilter

# OUR BROCHURE OVERVIEW

Get more information on demand

Level 1: Corporate Brochure



Level 2: Area Brochures



Level 3: Product Brochures



Level 4: Technical Data Sheets



Level 5: Manuals



More information about our products on [www.donaldson.com](http://www.donaldson.com)

**Donaldson**<sup>®</sup>  
**Ultrafilter**

Compressed Air Filtration · Filters for Sterile Air, Steam and Liquids · Refrigerant Drying · Adsorption Drying · Condensate Drains · Condensate Purification Systems · Process Air and Gas Processing



**Donaldson**<sup>®</sup>  
FILTRATION SOLUTIONS

### Total Filtration Management

Donaldson offers a wide variety of solutions to reduce your energy costs, improve your productivity, guarantee production quality and help protect the environment.

### Total Filtration Service

A comprehensive range of services keeps your production at peak performance and at the lowest total cost of ownership.

Please contact us:  
Donaldson Filtration Deutschland GmbH  
Büssingstraße 1  
D-42781 Haan · Germany  
Phone: +49(0)21 29 56 90  
[CAP-europe@donaldson.com](mailto:CAP-europe@donaldson.com)  
[www.donaldson.com](http://www.donaldson.com)

North America  
Phone: +1 800 543 3634  
[processfilters@donaldson.com](mailto:processfilters@donaldson.com)

Southeast Asia  
Phone: +65 6311 7373  
[CAPSEA@Donaldson.com](mailto:CAPSEA@Donaldson.com)